

Ecooustic® Bio Tile Installation + Care

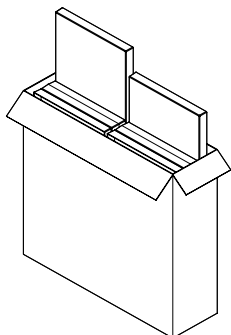

ASSEMBLY INSTRUCTIONS

Supplied



8 x Bio Tiles, 8 x Infills
 Sold in packs of 8 per finish
 13 x 4-way Clear ABS Joiner Clips
 (inc. 1 spare) Clip template
 Installation instructions

Source

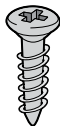

Flat-head c/sunk
 25mm (1") 10g
 [4-8 per tile]



Power drill

Essential

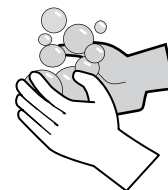

Clean hands
 Handle with care
 during installation

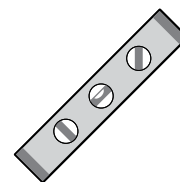

Spirit level

CLIPS

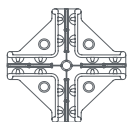

Complete
 Use a complete clip
 for each junction of
 4 tiles

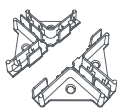

Half
 Break a clip in half for
 each straight edge 2 tile
 joins

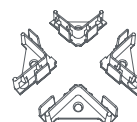

Quarter
 Break clip into quarters
 for each single tile
 corner

WALL INSTALLATION

Step 1

Draw a datum line on the wall and mark the setout point in which the tiles are to be installed.

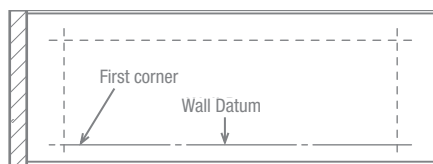

Step 2

Using fixings suitable for your substrate, fix the first corner in place.
 Note: Always use a mechanical means of fixing. 4 x joiner clips recommended for wall applications

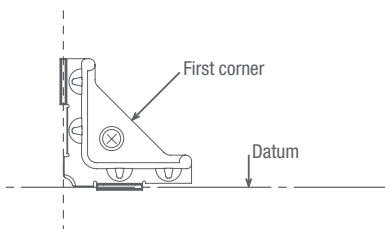

Step 3

Use the supplied template to fix the next 3 clips (plus clips for adjoining tile if required) in place. Use 6 clips for ceiling installations.



Step 4

Use the template work up the wall in columns. Finish the top with corner clips on corners + edge clips on straight joins.
 Note: never use the tiles to measure spacing.

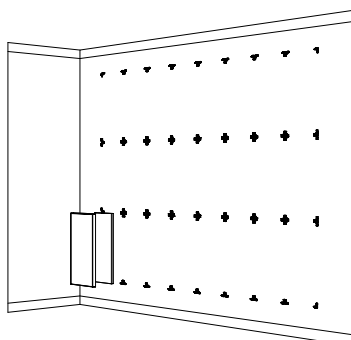

Step 5

Following the installation of two columns of clips, double check the spacing by installing the first column of tiles, ensuring Ecoustic Infills are inserted into each tile shell. Always stay one column ahead of the installed tiles to ensure the tiles don't interfere with the clip spacing.

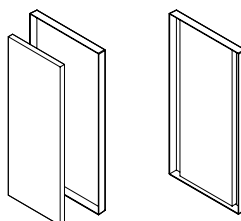

Step 6

Install the rest of your clips and put up the tiles to finish.

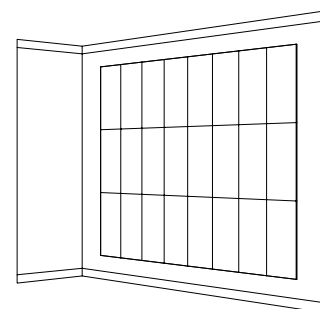

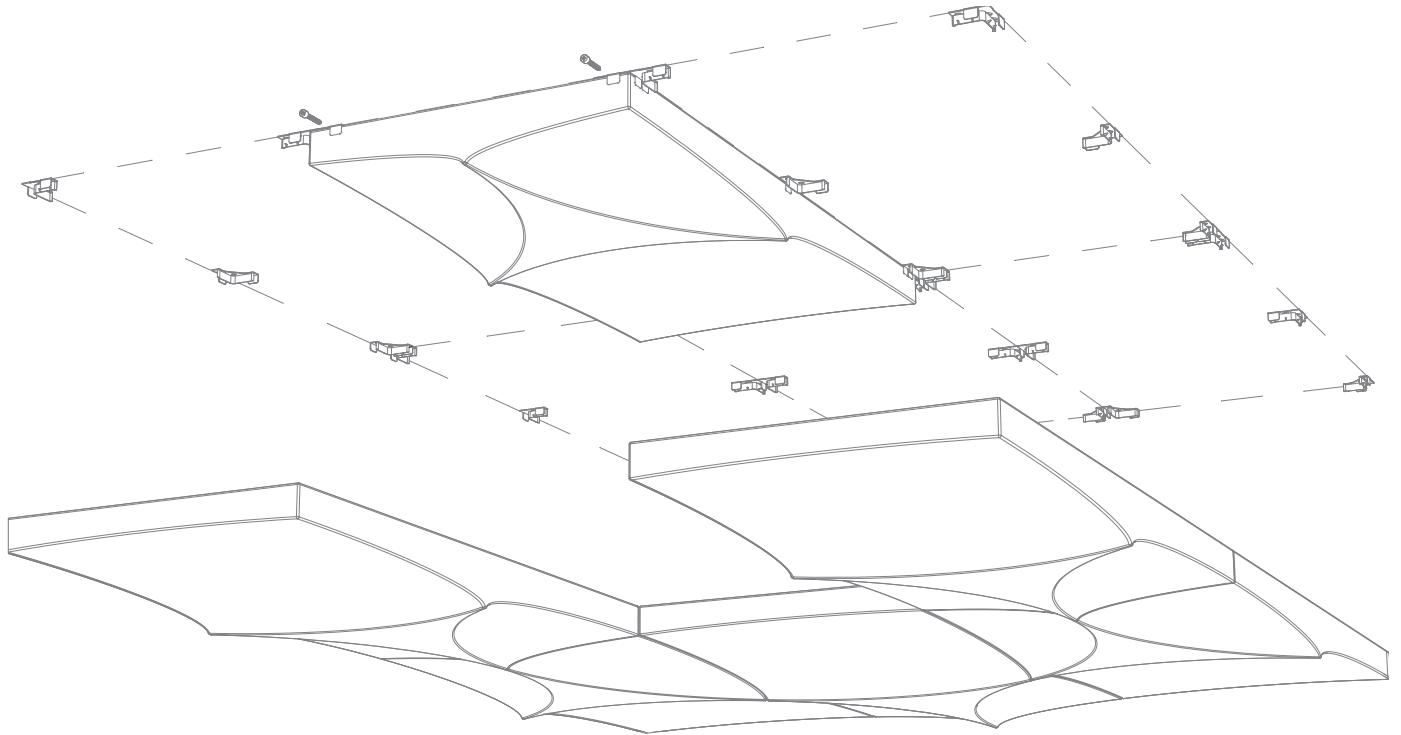

CEILING INSTALLATION

Follow **Steps 1 - 4** on page 2 - allowing for 6 joiner clips per tile at Step 3.

Steps 5 + 6

Minimum 1 external mechanical fastener per tile plus adhesive recommended.

Please Note

- Ecoustic Bio Tiles are manufactured from natural materials and will stain if soiled or wet with liquids.

Regular Care

- Protect from direct heat and sunlight.
- Do not expose to moisture, liquids or substances that may cause staining.
- To prevent dust build up, lightly dust with a soft cloth without repeated rubbing or excessive pressure.
- Do not clean with liquids, powders, chemicals, wet wipes or damp cloths.
- Wetting of the tile surface may permanently mark or change the colour of the tile.