

Ecooustic® Matrix

—
A dynamic modular wall tile designed to
provide quality sound absorption

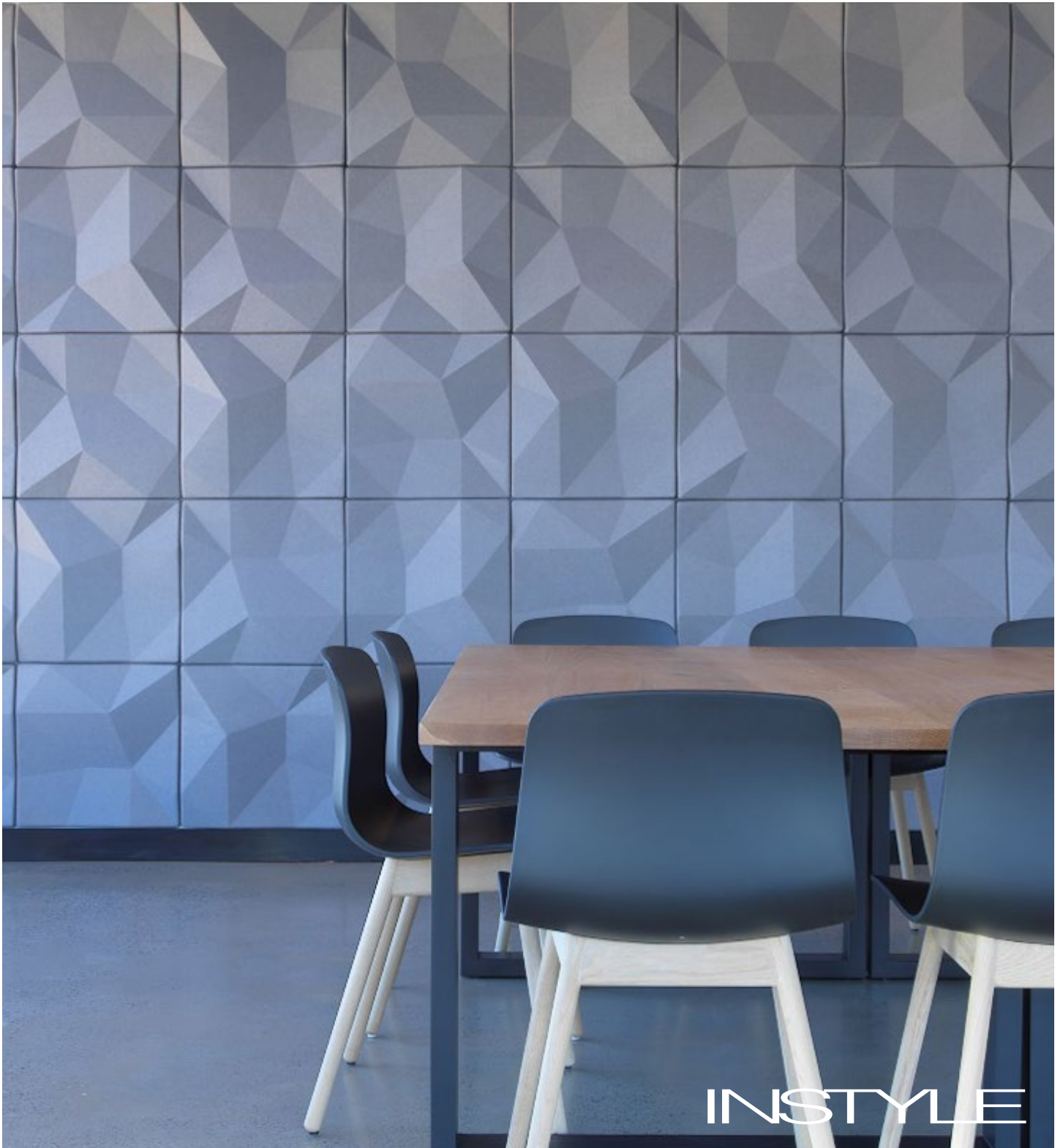

Front View

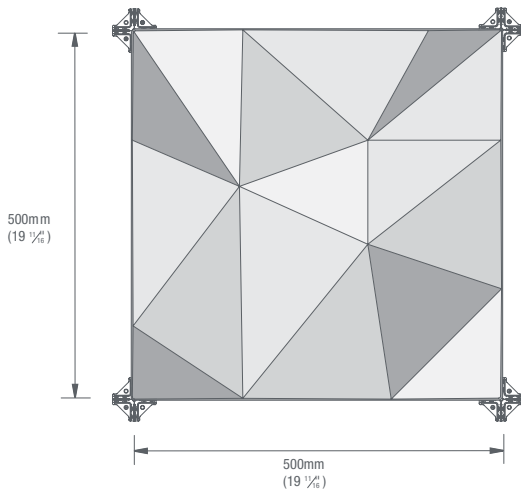

Side View

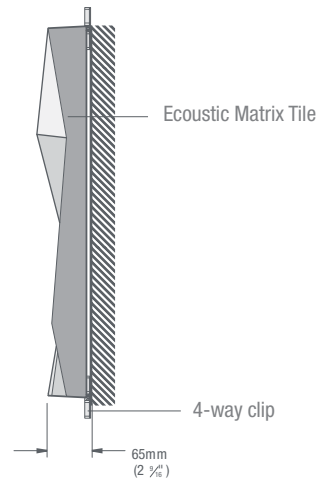

- PRODUCT** Ecoustic® Matrix Wall Tile
- COMPOSITION** 100% polyester (<23% PC + PI recycled PET)
- DIMENSIONS** 500mm (w) x 500mm (h) x 65mm (d)
- ACOUSTIC** NRC 0.65 / α_w 0.55(MH)
NRC 0.9 / α_w 0.75(MH) (Ecoustic® Infill increases sound absorption by over 35%)

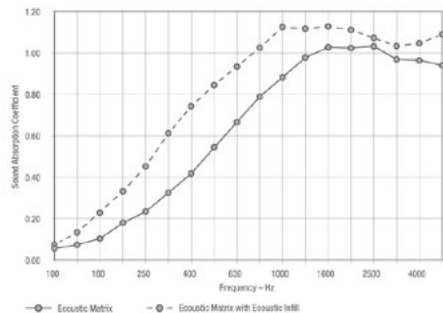

- FIRE TEST** AS/ISO 9705 Group 1
SMOGR <100
- GB8624-2012** Grade B1
- APPLICATION** wall + ceiling (must be glued)
- ORIGIN** Made in Australia
- WARRANTY** A 12 month warranty is provided against manufacturing defects. Internal installation only, outdoor use will void any warranty

Please contact your representative for CAD drawings

BENEFITS

Lightweight, Easy to Handle + Install: Position the 4-way clips using the template provided, then simply press the tile into place. The tiles can be easily moved or extended at a later stage.

Designed for the Environment



Building Rating Systems: Matrix will contribute the following points for Green Star, LEED + WELL building standards.

Criteria	Green Star	LEED	WELL
Recycled Content	✓	✓	NA
Low VOC	✓	✓	✓
Recycling Program	✓	✓	NA
EPD	✓	✓	NA
Declare Label	NA	✓	✓
Greentag Level A Certification	✓	✓	✓
Toxic Material Reduction	NA	NA	✓
Sound Reducing Surfaces	NA	NA	✓

HOW TO SPECIFY

DESIGN	Ecoustic® Matrix Wall Tile
COLOUR	Select from Ecoustic® Felt colours
ECOUSTIC® INFILL	Optional extra - order separately

Screws

Flat-head c/sunk 25mm (1") 10g
[2 per 4-way clip]
Not supplied

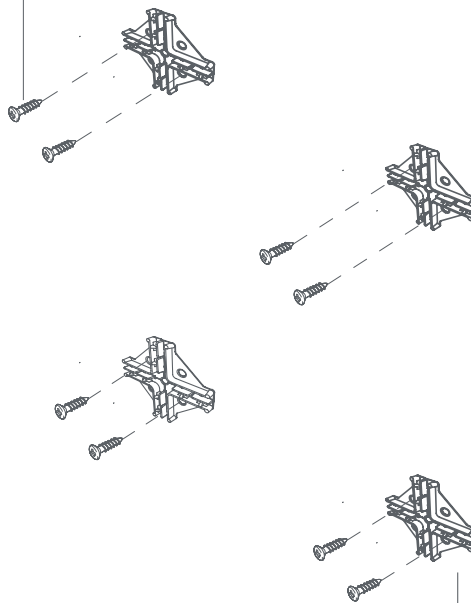
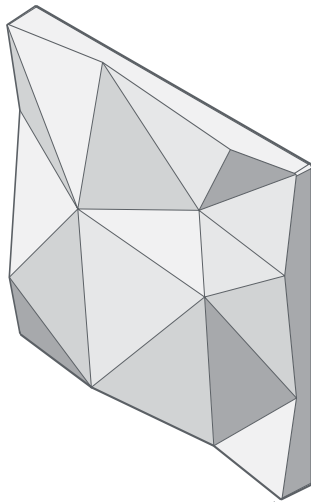

Ecoustic® Matrix Wall Tile

100% polyester (up to 23% recycled content)
8 tiles per box in a single colour

4 way clip

Clear ABS
8 + 1 spare 4-way clips are supplied with each box
Single clip template is included in each box

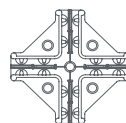

Complete

Use a complete clip for each junction of 4 tiles

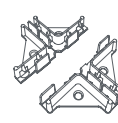

Half

Break a clip in half for each straight edge 2 tile joins

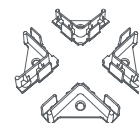

Quarter

Break clip into quarters for each single tile corner

Example 2m x 2m Clip Layout

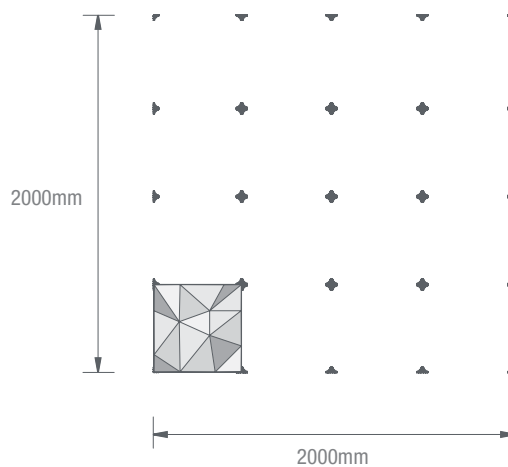

Product may vary in colour due to the nature of the media
Please refer to website for current colour range
Variation in fibre mix and colour is an inherent feature of this product and variation from batch to batch may occur