

Ecoustic® Torque Ceiling Installation + Care



Ecoustic® Torque Ceiling Tile Installation

ASSEMBLY INSTRUCTIONS

Supplied

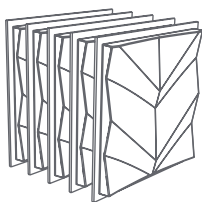

8 x Ecoustic® Torque Ceiling tiles
(595 x 595mm or 1195 x 595mm)
Sold as single colour per box

Source

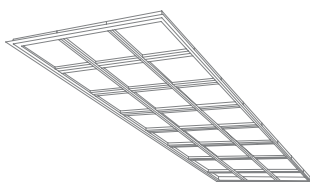

Pre-existing or newly installed drop
ceiling T-frame

600 x 600mm [centres]
or
1200 x 600mm [centres]

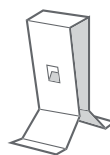

Hold down clip
4 per tile

Suitable for your grid
system

Essential



Clean hands
Handle with care
during installation

INSTALLATION

Step 1

Check the pre-existing or newly installed frame in which to suspend the Ecoustic® Torque Ceiling Tile.

Ensure the frame has been correctly installed with a suitable sized aperture for the tiles and the frame is square and true.

Step 2

The return flange of the tile will locate onto the landing of the suspended ceiling frame. The tiles can be dropped in place from the rear of the frame or slotted through from the visible side.

Take care not to bend the tile. The use of suitable Hold Down Clips is mandatory on Ecoustic® Torque Ceiling Tile, 4 per tile.

Step 3

Continue to fill the frame with Torque Ceiling or Torque Coffered Ceiling Tile.

Finish the installation in a discreet area as the last tile can remain unclipped to act as access to the plenum.

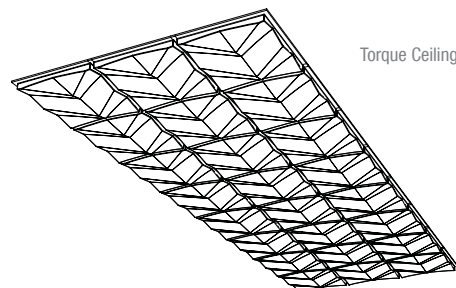
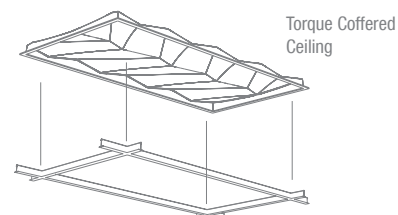
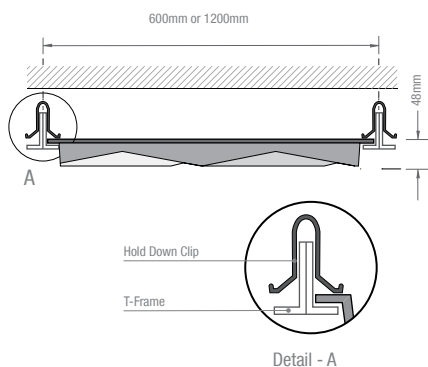
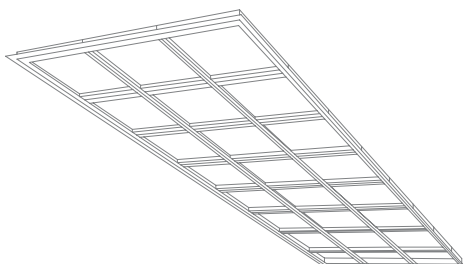

Ecoustic® Torque Ceiling Care

Please Note

- Care must be taken when cleaning as these instructions apply to the fabric face only and the possible effect of the cleaning regime on underlying bases and ceiling surface must be considered
- For these reasons it is suggested to spot clean only and that it be carried out by a professional cleaner

Regular Care

- Protect from direct heat and sunlight
- To prevent dust build up, lightly dust with a soft cloth or vacuum with a soft brush attachment

Cleaning

- Professional cleaning is always recommended
- Always test any any cleaning products on an inconspicuous area prior to commencing cleaning
- Blot any excess spills from the material with a dry clean sponge or cloth
- Treat all stains and spills as soon as possible
- Most marks can be spot cleaned by lightly wetting the affected area with a mild detergent and warm water solution
- Do not saturate the tile
- Do not scrub or abrade the tile surface as this will affect the surface finish
- Once the stain or mark has been loosened then blot the excess solution out with a dry clean sponge or cloth
- Sponge afterwards with clean warm water and dry any excess moisture with a dry clean sponge or cloth
- The product can also be spot cleaned with dry cleaning fluid, lightly sponge a small amount of dry cleaning fluid and blot
- Dry away from direct heat and sunlight
- Do not use carpet shampoo