

ECOUSTIC® HANG UPS - INSTALLATION OPTIONS

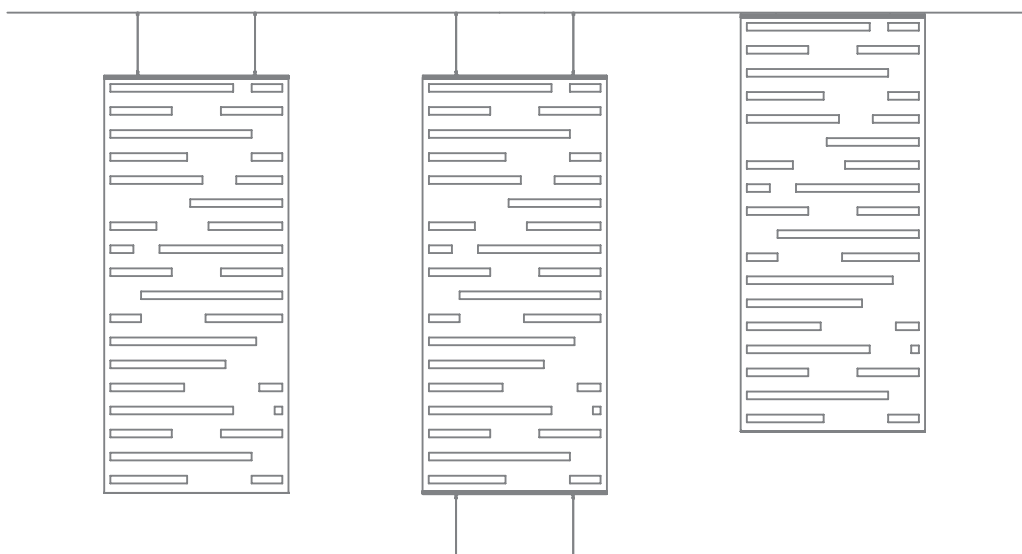
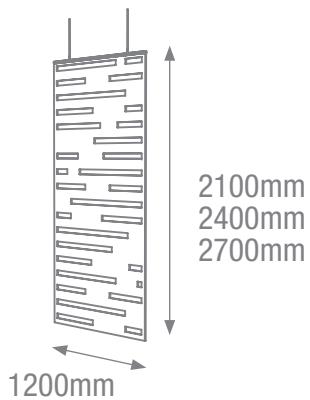

EXTRUSION ABOVE

ABOVE + BELOW

EXTRUSION DIRECT FIX

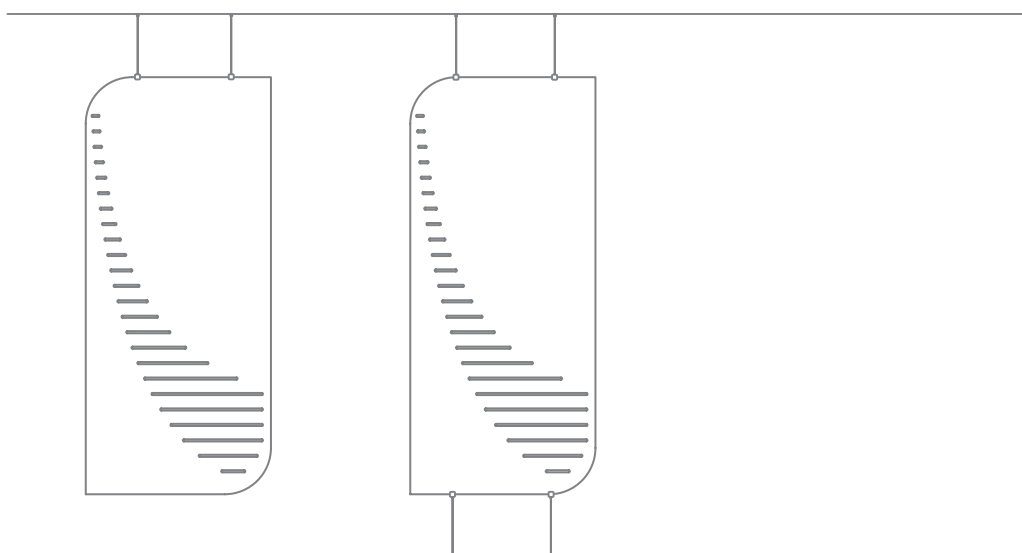

HANG UP CLAMPS ABOVE

ABOVE + BELOW

INSTALLATION OPTIONS

H1. Friction Fit + Adhesive

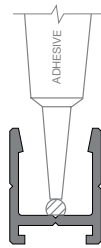

Apply continuous bead of appropriate adhesive to underside of Hang Up extrusion.

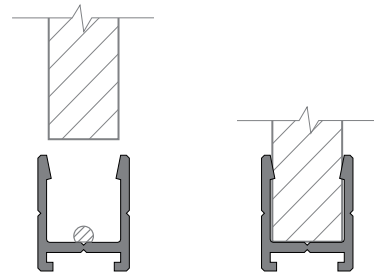

Friction fit the Hang Up to the extrusion, applying equal pressure along the length of the Hang Up.

H2. Fastener From Side

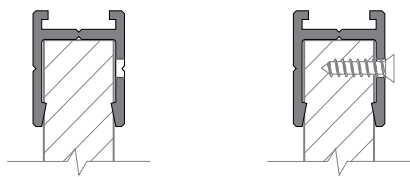

Attach extrusion to Hang Up and fasten screw through extrusion recess.

H3. Fastener From Above

Ecoustic® Solid Colour

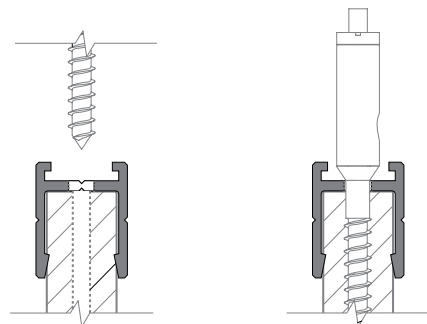

Attach extrusion with pre-drilled hole to Hang Up. Twist cable fixture and screw into Hang Up through pre-drilled hole.

Ecoustic® Felt Screen 25mm

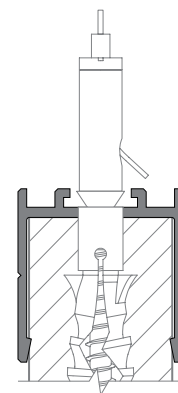

Continued on page 3.

A STRUCTURAL ENGINEER'S SAFETY CERTIFICATION IS RECOMMENDED FOR ALL OVERHEAD INSTALLATIONS

INSTALLATION OPTIONS

Continued - Ecooustic® Felt Screen 25mm

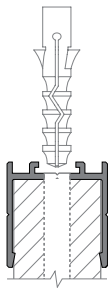

Anchor Orientation

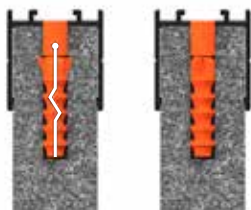

Attach extrusion to Hang Up and reverse-drill hole for anchor into Hang Up through pre-drilled holes in extrusion.* Insert the anchor into Hang Up.

Please Note: Ensure the anchor split line faces the end of the Hang Up (see diagram above).

Attach cable fixture to exposed screw head before fastening the screw into the anchor.

Push and hold down the cable clutch while threading the cable through to the desired length. Cut any excess cable.

Hang Up Compression

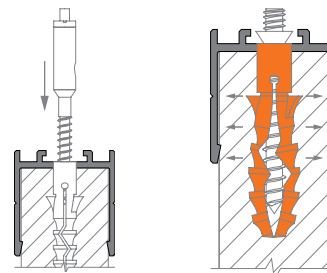

Correct anchor orientation will ensure the Hang Up substrate is compressed against the extrusion arms and held securely in place when the fastener is inserted.

* Please Note: holes must be 200mm min. from Hang Up end.

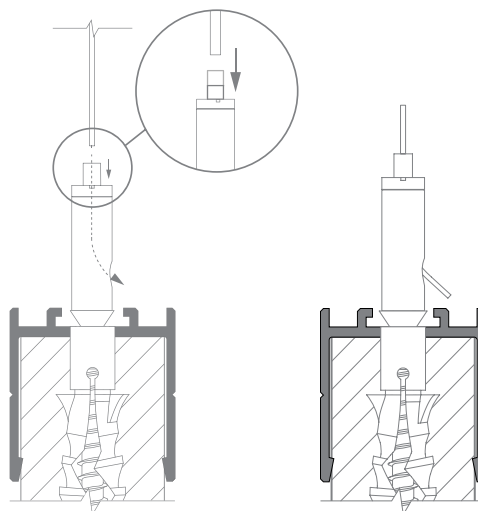

For installations using assembly option 3 (Ecooustic® Felt Screen 25mm), plasterboard anchors are required. These are supplied with Ecooustic® Felt Screen 25mm Hang Ups and are also available at any leading hardware store.

Optimal size of anchors are 10mm in diameter (nominal anchor: Ramset RamPlug 10mm x 50mm).

CEILING SUSPENSION LOCATION GUIDE

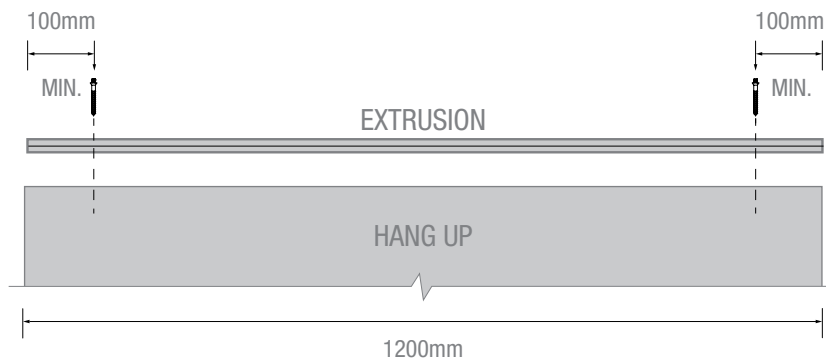

Suspension points should be placed minimum 100mm from either end of the Hang Up

CABLE INSTALLATION OPTIONS

Option A - Ecoustic® Hang Up Screw

Follow assembly option H3, attaching cable fixture to exposed screw head before fastening the screw into the Hang Up.

Push and hold down the cable clutch while threading the cable through to the desired length. Cut any excess cable.

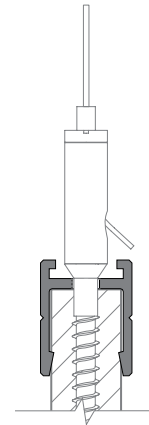

Option B - Sliding Cable Mount Via Extrusion

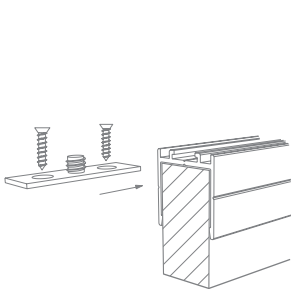

After extrusion is secured to Hang Up, insert sliding rail into extrusion. Secure cable fixture to exposed screw head with supplied washer between.

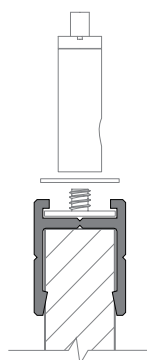

Push and hold down the cable clutch while threading the cable through to the desired length. Cut any excess cable. Slide cable clutch and rail to desired Hang Up location and secure.

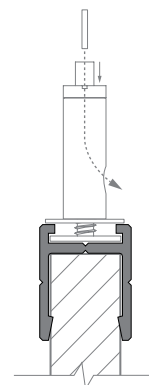

INSTALLATION OPTIONS

Option C - Hang Up Clamp

For installation without aluminium extrusion

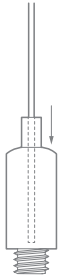

Push and hold down the cable clutch while threading the cable through to the desired length. Cut any excess cable.

Attach cable fixture to clamp body.

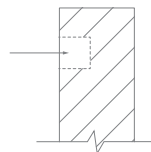
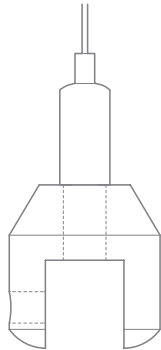

To avoid panel compression, drill a 3mm \varnothing pilot hole for the clamp's grub screw in the Hang Up panel.

Align clamp assembly before fixing it to the Hang Up via the grub screw provided.

*NB: clamps must be min. 100mm from Hang Up end

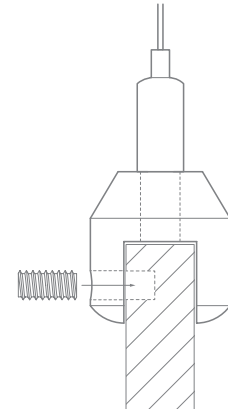

Direct Fix Installation

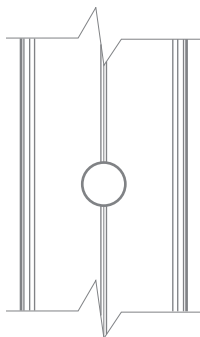

Secure appropriate fasteners into substrate through pre-drilled holes in Hang Up extrusion.

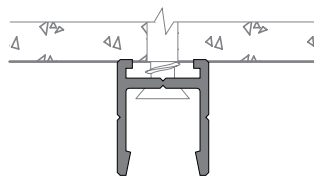

Secure Hang Up to extrusions using the options outlined on page 2.

CARE

Please Note

- Ecoustic® Hang Ups should be removed from the ceiling or wall to ensure they can be cleaned safely.
- It is recommended to spot clean only by a professional cleaner.

Regular Care

- Protect from direct heat and sunlight.
- To prevent dust build up, lightly dust with a soft cloth or vacuum with a soft brush attachment.

Spot Cleaning

- Professional cleaning is always recommended.
- Always test any cleaning products on an inconspicuous area prior to commencing cleaning.
- Blot any excess spills from the material with a dry clean sponge or cloth.
- Treat all stains and spills as soon as possible.
- Most marks can be spot cleaned by lightly wetting the affected area with a mild detergent and warm water solution.
- Do not saturate the panel.
- Do not scrub or abrade the fabric as this will affect the surface finish.
- Once the stain or mark has been loosened then blot the excess solution out with a dry clean cloth.
- Sponge afterwards with clean warm water and mop any excess moisture with a dry clean sponge or cloth.
- The surface can also be spot cleaned with dry cleaning fluid. Lightly sponge a small amount of dry cleaning fluid and blot.
- Dry away from direct heat and sunlight.
- Avoid the use carpet shampoos.