

Ecoustic® Intersect Installation + Care



INSTYLE

Components - Landscape

SUPPLIED IN EACH BOX

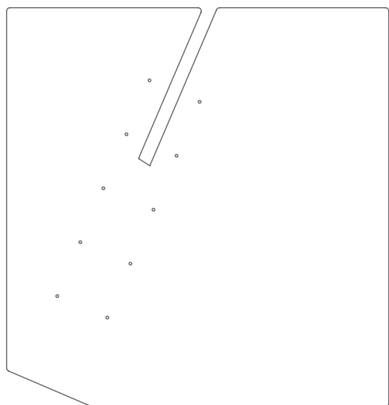

INTERSECT PANEL - 5 EDGES

Available in 6 colourways. 1 per box (Box 3).

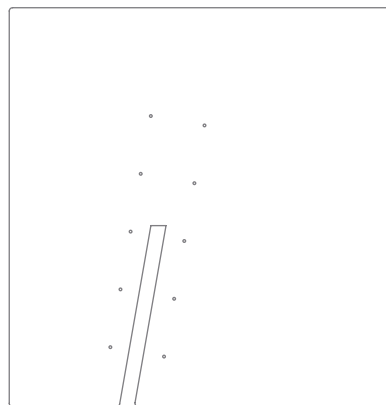

INTERSECT PANEL - 4 EDGES

Available in 6 Colourways. 1 per box (Box 3).

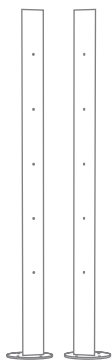

POSTS

Black finish. 2 per box (Box 2).

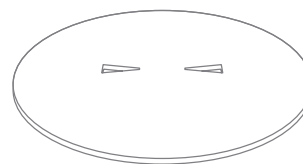

BASE

Black finish. 1 per box (Box 1).



X 8

SHORT SCREWS

For securing base to posts. 8 per box (Box 2).

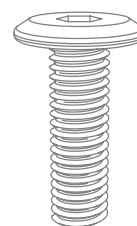

X 20

LONG SCREWS

For securing Intersect panels to posts. 20 per box (Box 2).

Components - Portrait

SUPPLIED IN EACH BOX

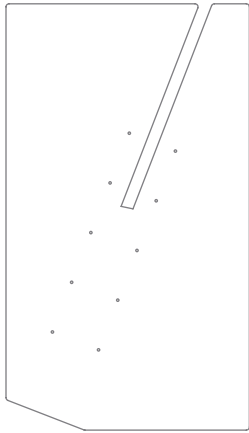

INTERSECT PANEL - 5 EDGES

Available in 6 colourways. 1 per box (Box 3).

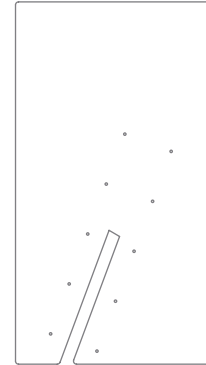

INTERSECT PANEL - 4 EDGES

Available in 6 colourways. 1 per box (Box 3).

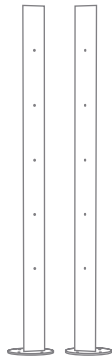

POSTS

Black finish. 2 per box (Box 2).

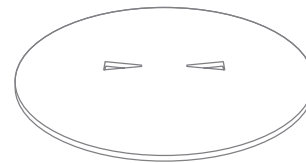

BASE

Black finish. 1 per box (Box 1).



X 8

SHORT SCREWS

For securing base to posts. 8 per box (Box 2).

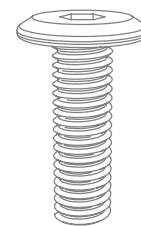

X 20

LONG SCREWS

For securing Intersect panels to posts. 20 per box (Box 2).

Ecoustic® Intersect Installation

ASSEMBLY INSTRUCTIONS

Step 1

Carefully slide both Intersect posts through the Intersect base, avoiding contact between the posts and the base until the post feet come into contact with the base

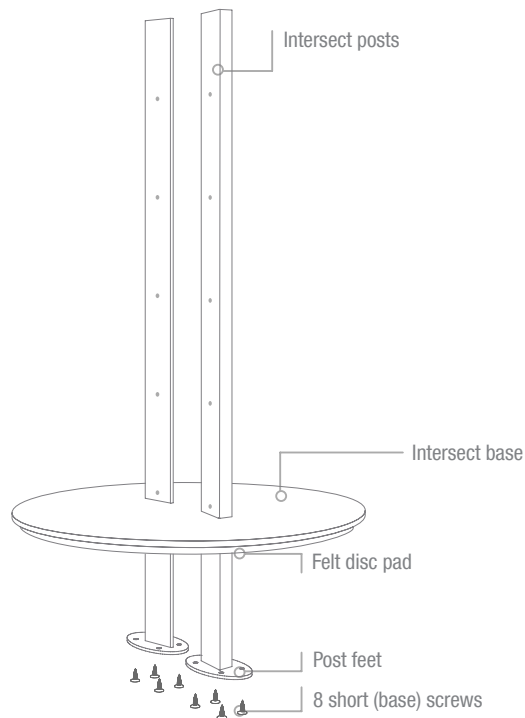

Step 2

Fasten each of the 8 short base screws supplied through the post feet into the Intersect base

Step 3

Remove Intersect panels from protective surrounds

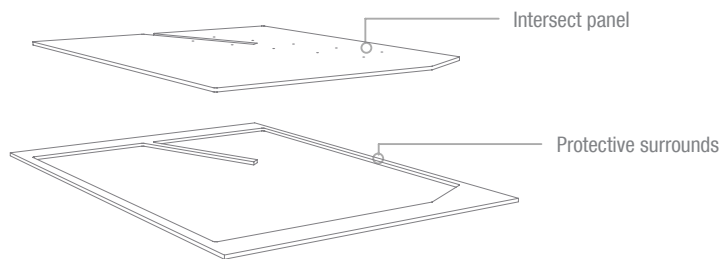

Step 4

Position the Intersect 5-edged panel between the Intersect posts with short edge of the panel aligned horizontally onto the base

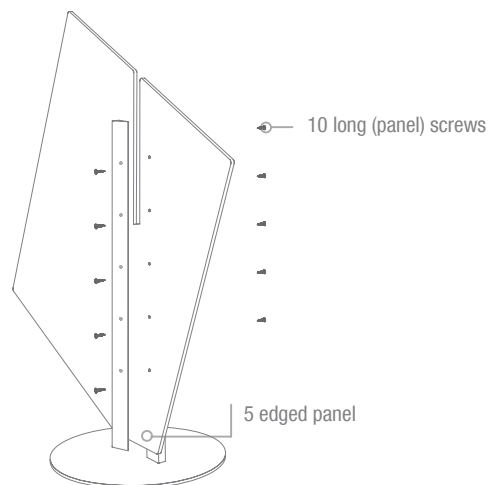

Step 5

Align panel holes with post threads and lightly fasten 10 of the 20 long (panel) screws supplied into the posts through the 5-edged panel

Ecoustic® Intersect Installation

ASSEMBLY INSTRUCTIONS

Step 6

Lower the 4-edged Intersect panel over the installed panel ensuring the slots of each panel intersect.

Step 7

Align holes of the 4-edged panel with post threads and lightly fasten remaining 10 long (panel) screws supplied into the posts through the 4-edged panel.

Step 8

Check both Intersect panels are resting on the face of each post, then finally check tighten all 20 of the long (panel) screws.

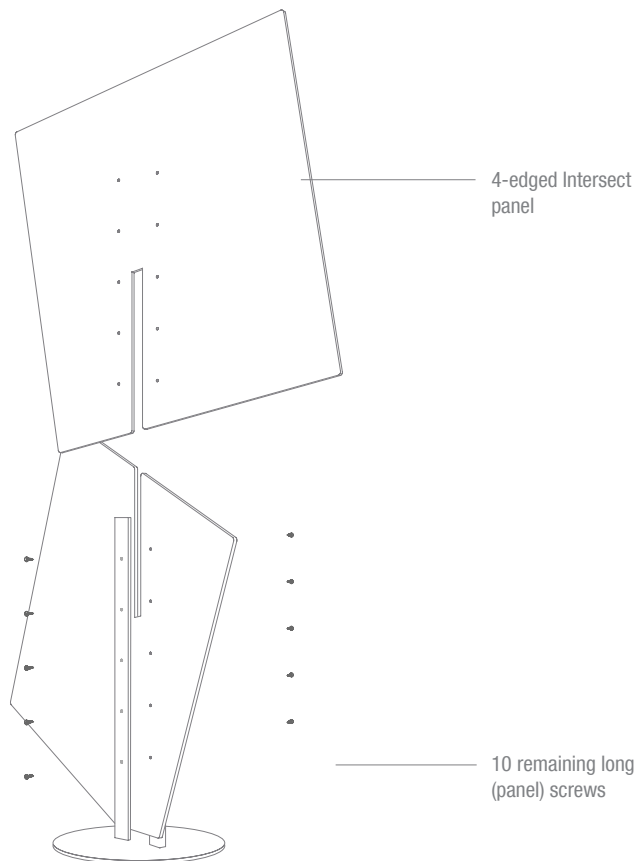

Your Intersect Partition is now complete!

Important: Please handle Intersect Partitions by holding onto the posts rather than the panels.

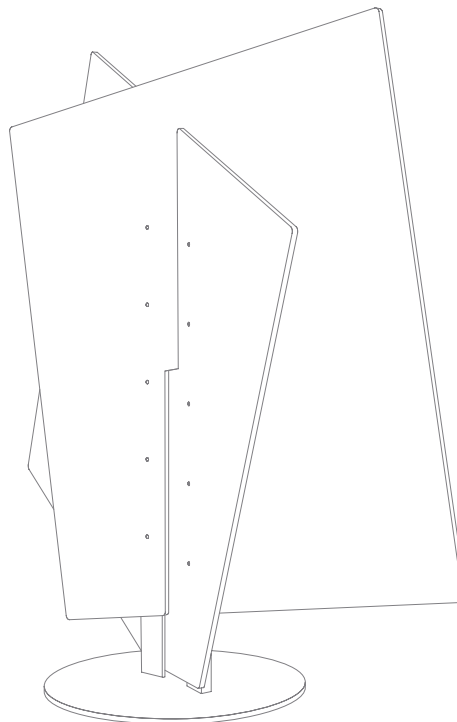

Ecoustic® Intersect Care

Please Note

- Consideration must be given to any possible effect of the cleaning regime on the underlying glue or backing board. It is recommended that spot cleaning only is used and that it is carried out by a professional cleaner.

Regular Care

- Protect from direct heat and sunlight.
- To prevent dust build up, lightly dust with a soft cloth or vacuum with a soft brush attachment.

Spot Cleaning

- Professional cleaning is always recommended.
- Always test any cleaning products on an inconspicuous area prior to commencing cleaning.
- Blot any excess spills from the material with a dry clean sponge or cloth.
- Treat all stains and spills as soon as possible.
- Most marks can be spot cleaned by lightly wetting the affected area with a mild detergent and warm water solution.
- Do not saturate the panel, screen or felt.
- Do not scrub or abrade the product as this will affect the surface finish.
- Once the stain or mark has been loosened then blot the excess solution out with a dry clean cloth.
- Sponge afterwards with clean warm water and mop any excess moisture with a dry clean sponge or cloth.
- The product can also be spot cleaned with dry cleaning fluid. Lightly sponge a small amount of dry cleaning fluid and blot.
- Dry away from direct heat and sunlight.
- Avoid the use carpet shampoos.